

Plan View
Scale: 1/2"=1'-0"

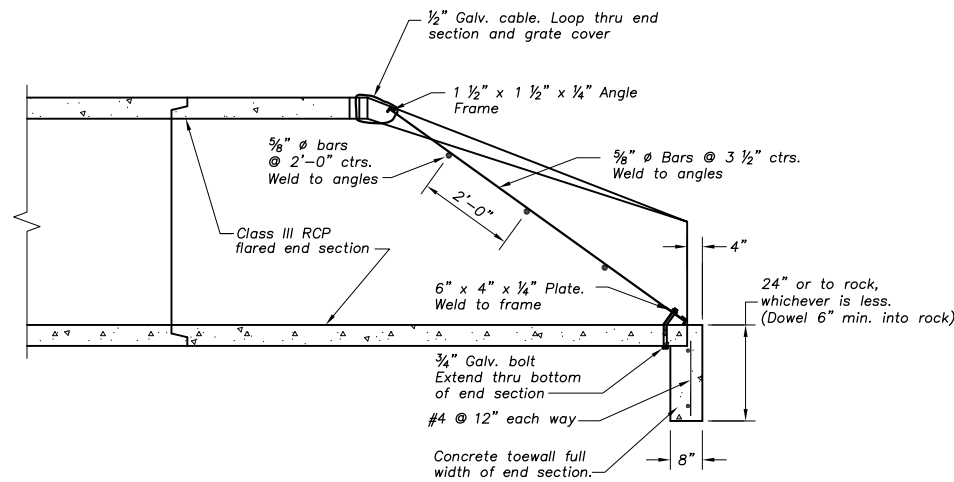

Section A-A
Not to Scale

END SECTION TOEWALL & GRATE

End Section Notes

- Overland Park Municipal Code (OPMC) and Overland Park Design and Construction Standards Manual (OPDCSM) are incorporated, except as otherwise noted.
- Use KCMMB4K Concrete throughout.
- Grate shall be provided for pipe sizes 24" to 60" (on inflow side only). Grades for pipes larger than 60" are only required if specified on the plan drawings.
- Grate cover detail shall be adjusted as necessary to fit end section provided.
- Maximum opening thru end section shall be no greater than 6". Adjust detail as necessary.
- All metal surfaces shall be hot dip zinc coated in accordance with ASTM A-123.
- Reinforcing steel shall be new billet, minimum Grade 40 as per ASTM A615, and shall be bent cold.
- All dimensions relative to reinforcing steel are to centerline of bars. 2" clearance shall be provided throughout unless noted otherwise. Tolerance of +/- 1/8" shall be permitted.
- All lap splices not shown shall be a minimum of 40 bar diameters in length.
- All dowels shall be accurately placed and securely tied in place prior to placement of bottom slab concrete. Sticking of dowels into fresh or partially hardened concrete will not be acceptable.
- All reinforcing steel shall be supported on fabricated steel bar supports @ 3'-0" maximum spacing.
- Do not scale these drawings for dimensions or clearances. Any questions regarding dimensions shall be brought to the attention of the City Engineer prior to construction.

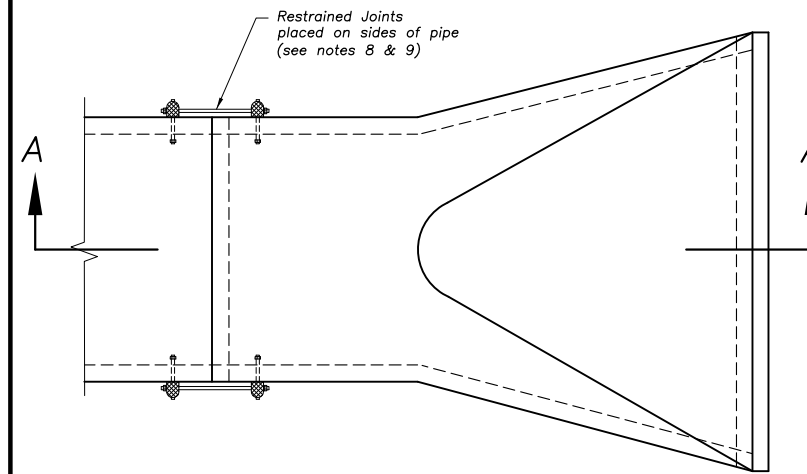

Plan View
Scale: 1/2"=1'-0"

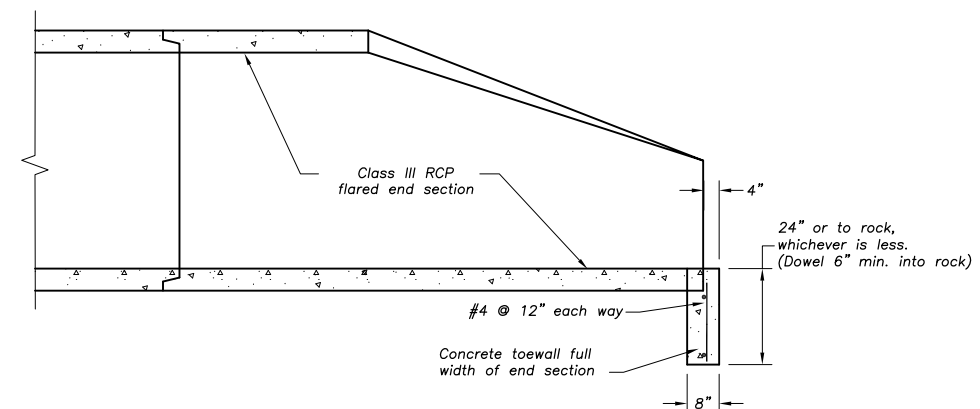

Section A-A
Not to Scale

END SECTION TOEWALL

End Section Notes

- Overland Park Municipal Code (OPMC) and Overland Park Design and Construction Standards Manual (OPDCSM) are incorporated, except as otherwise noted.
- Use KCMMB4K Concrete throughout.
- Reinforcing steel shall be new billet, minimum Grade 40 as per ASTM A615, and shall be bent cold.
- All dimensions relative to reinforcing steel are to centerline of bars. 2" clearance shall be provided throughout unless noted otherwise. Tolerance of +/- 1/8" shall be permitted.
- All lap splices not shown shall be a minimum of 40 bar diameters in length.
- All dowels shall be accurately placed and securely tied in place prior to placement of bottom slab concrete. Sticking of dowels into fresh or partially hardened concrete will not be acceptable.
- All reinforcing steel shall be supported on fabricated steel bar supports @ 3'-0" maximum spacing.
- The last three joints of RCP, including the end section, shall be mechanically restrained where discharging into unimproved systems.
- The restrained joint hardware shall be hot dip zinc coated in accordance with ASTM A-123.
- The handrail shall be required on end sections 42" height or larger.
- Do not scale these drawings for dimensions or clearances. Any questions regarding dimensions shall be brought to the attention of the City Engineer prior to construction.

Year 2018 Edition

REVISIONS:	
05/20/03	Notes
07/01/03	Concrete Mix Designation
Jan. 2006	Miscellaneous
RELATED ORDINANCES:	
OPMC Title 15	

OVERLAND PARK
KANSAS
ABOVE AND BEYOND. BY DESIGN.

DEPARTMENT OF PUBLIC WORKS
STANDARD DETAILS

END SECTION TOEWALL DETAIL